



Recorder



Flow



Pressure



Temp



Analyzer



Level

Datasheet

Vortex Flow Meter

SUP-LUGB

Supmea[®]

Committed to process automation solutions

Tel: 86-15158063876

E-mail: info@supmea.com

www.supmea.com

Datasheet**Vortex Flow Meter
SUP-LUGB**

The vortex flow meter is a flow meter that applies the Karman vortex principle. It is used to measure the flow of liquid, gas, and steam, and can also measure turbid liquid containing tiny particles and impurities. It is widely used in petroleum, chemical, pharmaceutical, papermaking, Metallurgy, electric power, environmental protection, food, and other industries.

Applications

- Petroleum
- Chemical
- Pharmaceutical
- Paper industry
- Metallurgy
- Electric power
- Environmental protection
- Food and beverage

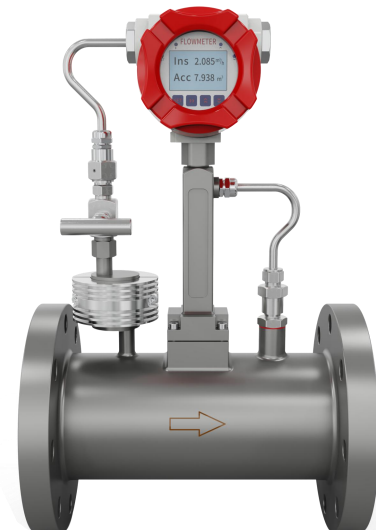
**Features**

- Ability to measure flow accurately and reliably.
- Low maintenance requirements.
- Easy to install and operate.
- Offer excellent long-term stability.
- Small pressure loss, wide range, high-accuracy.
- It has both analog standard signals and digital pulse signal output to match with computers and other digital systems.

Vortex Flow Meter**Principle**

The vortex flow meter measures the flow of steam, gas and low-viscosity liquid based on the theory of Kamen and Strohal about the generation of vortex and the relationship between vortex and flow. As shown in Figure 1, a triangular column is vertically inserted into the body, which is the source of the vortex. When the medium flows through the body, Karman vortices with opposite directions and regularity are alternately generated behind the triangular column. The separation frequency of the vortex is F . It is proportional to the flow velocity V of the medium. By detecting the number of vortices through the sensor head, the fluid flow rate can be measured, and then the volume flow rate of the measured medium can be calculated according to the diameter of the meter body.

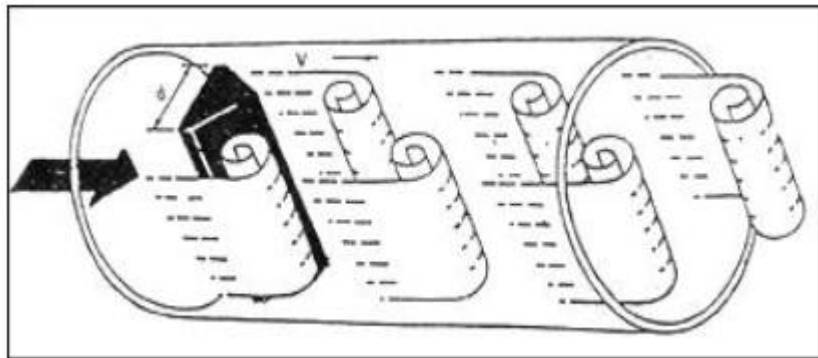

Figure 1

Calculated as follows:

$$F = St \cdot V / m \dots \dots \dots \text{Formula 1}$$

$$Q = 3600 \cdot F / K \dots \dots \dots \text{Formula 2}$$

$$M = Q \cdot \rho \dots \dots \dots \text{Formula 3}$$

In the formula:

1. F ...the vortex frequency generated by the fluid flowing through the triangular column of the vortex flow meter (unit: Hz)
2. St ...Strohal's constant (dimensionless)
3. V ... the average velocity of the fluid in the pipeline (unit: m/s)
4. m ...The ratio of the arc flow area on both sides of the triangular column to the cross-sectional area of the measuring pipe (unit: dimensionless)
5. d ...Width of the upstream surface of the triangular column in the meter body of the vortex flow meter (unit: m)
6. D ...The inner diameter of the vortex flow meter meter (unit: m)
7. Q ...Instantaneous volume flow rate (unit: m³/h)
8. K ...The instrument coefficient of the vortex flow meter (unit: number of pulses/cubic meter)
9. M ...Instantaneous mass flow rate (unit: kg/h)
10. ρ ...fluid density (unit: kg/m³)
11. Note: The vortex flow meters with different calibers have different instrument coefficient K values,

and the specific values are obtained through the actual calibration of the flow calibration device. That is, the number of pulses output by the sensor for one cubic meter of fluid flowing through the working condition.

Parameters	
Physical Parameters	
Items	Main parameters
Measuring medium	Liquid, gas, steam (saturated steam, superheated steam)
Nominal diameter	LUGB pipeline type: DN10-DN500; LUCB plug-in type: DN200-DN2000;
Accuracy	LUGB pipeline type: 1.0 %, 1.5 % (0.5 %, 0.2 % agreement supply) LUCB plug-in type: 2.5 % (1.5 %, 1.0 % agreement supply)
Turndown ratio	When the gas density is 1.2 kg/m ³ , the turndown ratio is 8:1 When the liquid density is 1000kg/m ³ , the turndown ratio is 8:1 When the medium density is different, the turndown ratio will change
Nominal pressure	LUGB pipeline flange clamp installation--DN10-DN500 (preferred pressure level PN2.5MPa); LUGB pipeline flange connection - DN10-DN80 (preferred pressure level PN2.5MPa); LUGB pipeline flange connection - DN100-DN200 (preferred pressure level PN1.6MPa); LUGB pipeline flange connection--DN250-DN500 (preferred pressure level PN1.0MPa) LUCB plug-in flange connection--DN200-DN2000 (preferred pressure level PN1.6MPa); Note: The clamp-on vortex street uses a special flange made by the manufacturer, and the matching flange is included in the factory; the preferred pressure level is the factory default pressure level, and other pressure levels or other flange standards can be negotiated for supply;
Medium temperature	LUGB pipeline type: -40°C~+150°C; -40°C~+260°C; -40°C~+320°C; -40°C~+420°C LUCB plug-in type: -40°C~+150°C; -40°C~+200°C
Ambient temperature	-20°C~+55°C (common type)
Relative humidity	5%-95%RH
Atmospheric pressure	86kPa~106kPa
Electrical interface	M20*1.5 internal thread (other types of connectors can be supplied by agreement)
Degree of protection	IP65 (IP67, IP68 can be supplied by agreement)
Body material	Stainless steel (other materials are supplied by agreement)
Pressure loss	$\Delta P \leq 1.2 p_{work} V^2$ (ΔP unit is Pa; p_{work} unit is kg/m ³ ; V unit is m/s)
Calibration method	When the flow meter of our company is calibrated at the factory, the downstream pressure of the flow meter is taken
Electrical Parameters (D2/X1)	

Items	Main parameters
Working power	D2 type: 24VDC±10%; X1 type: lithium battery 3.6 VDC (battery service life ≥ 2 years); 24VDC±10%
Load resistance	When outputting current, the load resistance must be ≤300Ω (including wire resistance)
Display	D2 type: no display X1 type: two-line liquid crystal character display, simultaneously displaying instantaneous flow and cumulative flow
Output signal	The instantaneous flow rate of the working condition corresponds to the frequency pulse (low level ≤ 1V, high level ≥ 6V) The isolated two-wire 4-20mA output corresponding to the displayed instantaneous flow
	Electrical parameters (E3/E4)
Working power	E3 type: 24VDC±5%, lithium battery 3.6 VDC (battery service life greater than 2 years) Optional E4 type: 24VDC±10%
Load Resistance	When outputting current, the load resistance must be ≤300Ω (including wire resistance)
Display	Intelligent dot matrix display type-Chinese or English 128*64 dot matrix LCD display, which can display instantaneous flow, cumulative flow, working temperature, working pressure, battery voltage, working density, working volume flow, output signal, menu number of revisions, etc.;
Output signal	The instantaneous flow rate of the working condition corresponds to the frequency pulse (low level ≤ 1V, high level ≥ 10V) The isolated two-wire 4-20mA output corresponding to the display of instantaneous flow (E3 type) The isolated three-wire 4-20mA output corresponding to the display of instantaneous flow (E4 type)
Communication	RS485
Temperature sensor type	Three-wire PT100
Pressure sensor type	Four-wire diffused silicon pressure sensor
Temperature display accuracy	Better than 0.2%F.S
Pressure display accuracy	Better than 0.2%F.S
Density calculation accuracy	Better than 0.1%
Calculation accuracy of compressibility factor	Better than 1%
Amplifier software scope	Superheated steam temperature and pressure compensation: temperature 0~430°C; pressure -0.1~20MPa Saturated steam compensation: temperature 0~360°C; pressure -0.1~20MPa Water temperature and pressure compensation: temperature 0~430°C; pressure -0.1~20MPa Oil temperature and pressure compensation: temperature (-20°C~150°C); Density $\rho_{20}=800\sim900\text{kg/m}^3$ (ρ_{20} is the density of petroleum at 20°C and 0.101325MPa) Natural gas temperature and pressure compensation: Absolute pressure: 0MPa<p≤12MPa

Thermodynamic temperature: $263\text{K} \leq T \leq 338\text{K}$
Mole fraction of CO₂: $0 \leq x_{\text{CO}_2} \leq 0.30$
Mole fraction of H₂: $0 \leq x_{\text{H}_2} \leq 0.10$
High calorific value: $20\text{MJ} \cdot \text{m}^{-3} \leq H_s \leq 48\text{MJ} \cdot \text{m}^{-3}$
Relative density: $0.55 \leq d \leq 0.90$
Mole fractions of other components:
CH₄: $0.5 \leq x_{\text{CH}_4} \leq 1.4$
N₂: $0 \leq x_{\text{N}_2} \leq 0.5$
C₂H₆: $0 \leq x_{\text{C}_2\text{H}_6} \leq 0.2$
C₃H₈: $0 \leq x_{\text{C}_3\text{H}_8} \leq 0.05$

Temperature compensation

No compensation, temperature compensation, pressure compensation, temperature and pressure compensation can be set arbitrarily

Wiring

A. Non-display pulse output type (three-wire voltage pulse) wiring

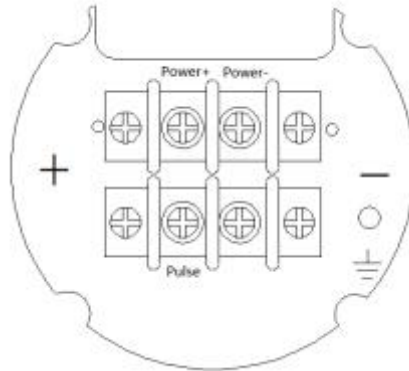

Power+: power supply 24/12VDC+	Note: When negative pole of the power supply and pulse input ground connection is not be shared, because the connections will be short-circuited.
Power-: power supply 24/12VDC-	
Pulse: pulse output	

B. Non-display current output type (two-wire 4-20mA) wiring

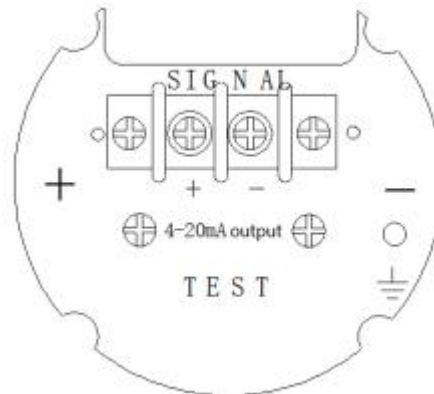

Power+: power supply 24VDC +	Note: K5 on the back circuit board is a short-circuit plug between the negative pole of the power supply and the ground. The factory default is the short-circuit state. When the external signal receiving system has a separate "ground", K5 needs to be disconnected, otherwise it will cause inaccurate measurement.
Power-: 4-20mA output	

C. On-site display without output type

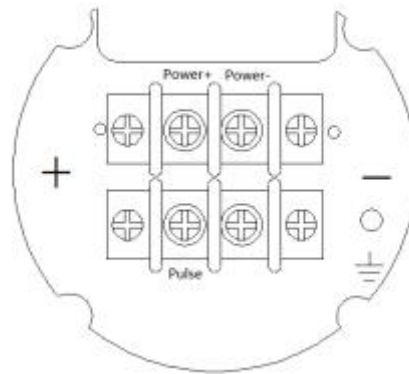

Power+: power supply 24VDC+	Note: When the negative pole of the external power supply and the negative pole of the pulse output do not share the same "ground", they should be short-circuited. This type of amplifier always needs battery power to work normally, so after the external power supply is turned on, it is still necessary to turn the battery switch to the "ON" position before it can be used normally.
Power-: power supply 24VDC-	
Pulse: output pulse	

D. On-site display pulse output type (three-wire voltage pulse)

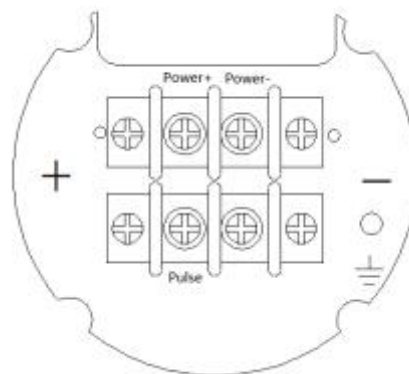

Power+: power supply 24VDC+	Note: When the negative pole of the external power supply and negative pole of the pulse input do not share "ground", they
Power-: power supply 24VDC-	

<p>Pulse: pulse output</p>	<p>should be short-circuited. This type of amplifier always requires battery power to work properly, so after the external power supply is turned on, you still need to turn the battery switch to the "ON" position to use it normally.</p>
----------------------------	--

E. On-site display current output type (two-wire system 4-20mA)

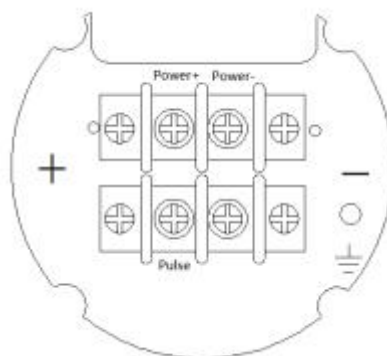

<p>Power+: power supply 24VDC+</p>	<p>Note: When the external signal receiving system has a separate "ground", the "pulse (secondary meter)" plug on the back circuit board needs to be disconnected, otherwise the measurement will be inaccurate. This type of amplifier always requires battery power to work properly, so after the external power supply is turned on, you still need to turn the battery switch to the "ON" position to use it normally.</p>
<p>Power-: 4-20mA output</p>	

F. Digital filter type wiring (First edition) wiring

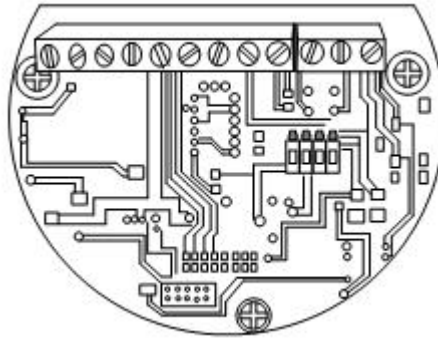

V+	power supply 24VDC+	Note: When the current is output, the terminals 1 and 2 of the switch K should be set to the ON position, and the terminals 3 and 4 should be set to the OFF position; when the pulse is output, the terminal 3 of the switch K should be set to the ON position, Terminals 1, 2, and 4 are set to the OFF position.
F	pulse output	
V-	pulse output: 24VDC- and pulse-; 4-20mA output: 4-20mA+	
A、 B	A:RS485+、 B:RS485-	

Note: Switch 4 is a short-circuit switch between the input power ground and the shell ground, and it should be in the OFF position under normal circumstances.

G.Digital filter type wiring (Second edition) wiring

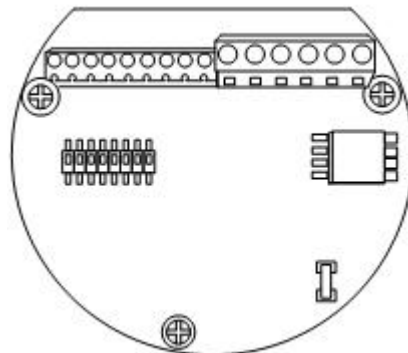

V+	power supply 24VDC+	Note: When the two-wire current is output, the terminals 1 and 2 of the switch K should be set to the ON position, and the terminals 3, 4, 5, 6, 7, 8 should be set to the OFF position; when the power supply negative When "ground", 5 should be set to ON position; when frequency
I	three-wire 4-20mA+	
F	pulse output	
V-	pulse output and three-wire 4-20mA : 24VDC- and pulse-; two-wire 4-20mA output: 4-20mA+	
A、 B	A:RS485+、 B:RS485-	

		output or three-wire current output, the 4, 5, 6, 7 terminals of switch K should be set to ON, and 1, 2 terminals should be set to OFF. When RS485 communication, set the terminal 8 of switch K to the ON position.
--	--	--

Note: The terminal board switch 5 is a short-circuit switch between the "power-" and the housing. When the signal-receiving end "power-" is not grounded, it must be opened to ground the "power-" (such as a secondary instrument) ; When the signal receiving terminal "power -" is grounded, it needs to be turned off (such as DCS).

H.Smart battery powered type wiring

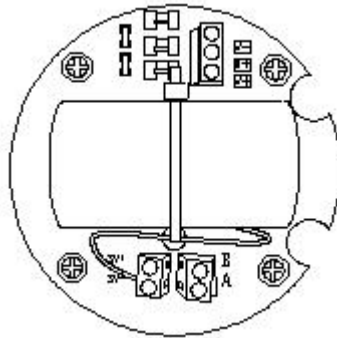

V+	Power supply 24VDC+	Note: This instrument has the function of automatic switching between 3.6V lithium battery and 24VDC. When only 3.6V lithium battery is needed for power supply, the battery switch is set to the "ON" position for normal use.
F	Pulse output	
V-	Pulse output: 24VDC- and pulse-; two-wire 4-20mA output: 4-20mA+	
A、 B	A:RS485+、 B:RS485-	

Note:

- 1) When inserting or removing the LCD and daily use of the above several amplifiers, do not press the LCD cable forcefully to prevent it from being broken and damaged;
- 2) T+, T-, T- are PT100 thermal resistance terminals; PV-, PV+, PI-, PI+ are pressure sensor terminals.

Dimension

Product Dimension:

SUP-LUGB-A Vortex flow meter max configuration size fig. (unit: mm)

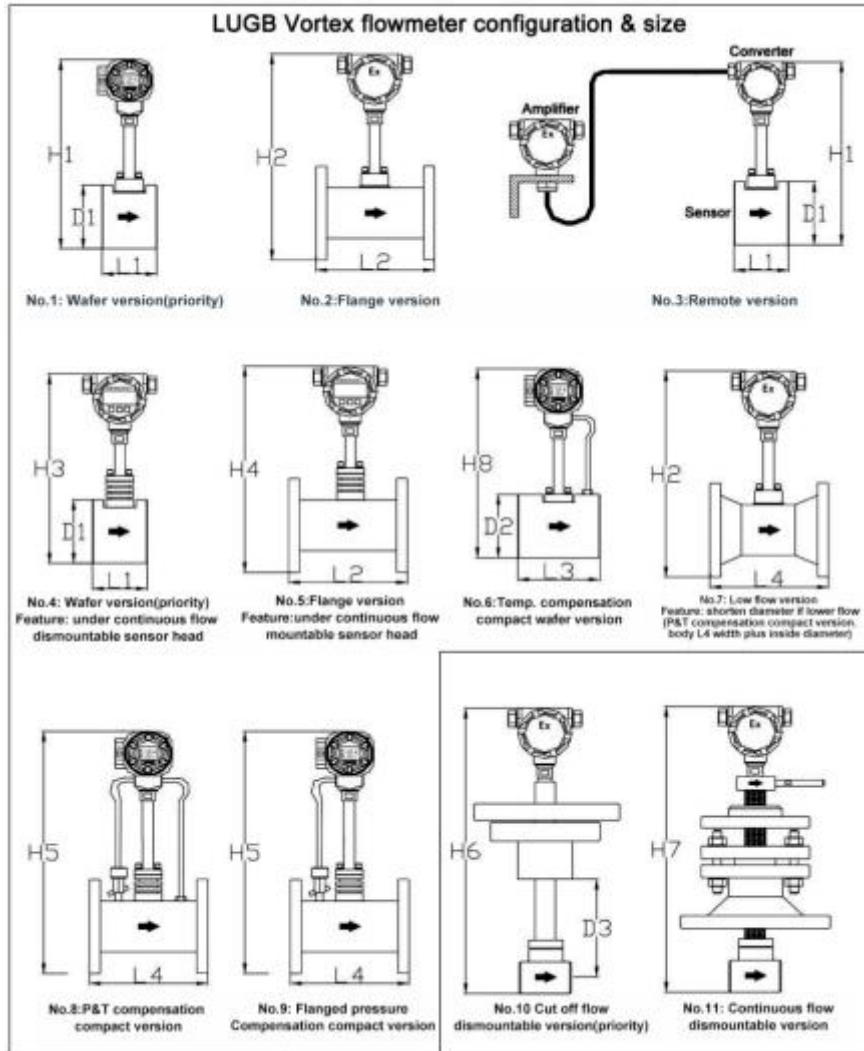

SUP-LUGB-A Vortex flow meter max configuration size table (unit: mm)

Dimension DN	H1	H2	H3	H4	H5	H6	H7	H8	D1	D2	D3	L1	L2	L3	L4
10	441	428							90			50	200		
15	445	430							95			50	200		
20	450	435							100			50	200		
25	451	440			455			428	100	60		50	200		275
32	456	452			468			432	105	65		54	200		275
40	435	468	477	505	505			477	92	92		78	200	112	275
50	438	480	484	518	518			484	98	98		78	200	112	275
65	453	502	495	535	535			495	110	110		78	200	112	275
80	476	515	519	550	550			519	134	134		90	225	112	300
100	499	534	543	571	571			543	158	158		78	250	112	350
125	520	564	560	599	599			560	175	175		78	275	112	375
150	545	593	585	631	631			585	200	200		100	300	140	400
200	595	647	635	682	682	530	1150	635	250	250	100	120	350	160	450
250	645	700	685	735	735	530	1150	685	300	300	125	140	400	180	500
300	695	750	735	785	785	580	1200	735	350	350	150	160	450	200	550
350	745	805	785	840	840	580	1200	785	400	400	175	165	500	220	600
400	795	861	835	895	895	630	1250	835	450	450	200	185	550	240	650
450	845	910	885	945	945	630	1250	885	500	500	225	205	600	260	700
500	895	965	935	998	998	680	1300	935	550	550	250	225	650	280	750
600						730	1350					300			
800						830	1450					400			
1000						930	1550					500			
1200						1130	1650					600			
1500						1230	1750					700			
1800						1330	1850					800			
2000						1430	1950					900			

Ordering code

SUP-LUGB-DNXX-A -M1-I1-MM1-J6-DT0-00-D0-V1-C0-P2-SI1-T1-IP1														Description	
SUP-LUGB	-	-	-	-	-	-	-	-	-	-	-	-	-	-	DN10-DN500
Pipe size	DNXX-A														
Type	M1													Integrated (meter head and body)	
	M2													Remote type (separation distance between meter head and body ≤ 10m)	
	M3													Submersible	
Installation	I1													Flange connection (required for temperature and pressure compensation)	
	I2													Flange mount (preferred type)	
	I3													Clamp type (needs to be customized)	
Medium	MM1													Universal for gas, liquid, and steam (digital filter smart display only)	
	MM2													Liquid	
	MM3													Gas	
	MM4													Saturated steam, superheated steam	
Accuracy	J6													1.0%(default)	
	J5													0.5%	
Display	DT0													Without on-site display type	
	DT1													On-site display type	
Transmission output	00													On-site display without transmission output	
	02													Two-wire 4-20mA output	
	08													Three-wire 4-20mA output	
	09													Pulse equivalent output (only for intelligent type)	
	010													Voltage pulse (low level ≤ 1V, high level ≥ 6V, pulse width ≥ 10 US)	
Communication output	D0													No communication output	
	D1													RS232	
	D2													RS485 (only for intelligent amplification)	

	D3		Hart
Power supply	V1		24VDC
	V3		12VDC
	V6		Battery-powered (3.6V lithium)
	V7		24V+3.6V dual power supply
Compensation type	C0		No compensation
	C1		Superheated steam temperature and pressure compensation
	C2		Pressure compensation
	C3		Temperature and pressure compensation
Pressure		P2	1.0 MPa (DN250-DN500)
		P3	1.6 MPa (DN100-DN200)
		P4	2.5 MPa (DN10-DN80)
		PZ	Other nominal pressure
Sensor head installation		SI1	Cut-off detachable
		SI2	Non-stop detachable ($\geq 320^{\circ}\text{C}$ must choose)
Temperature resistance		T1	$-40^{\circ}\text{C}-150^{\circ}\text{C}$
		T2	$-40^{\circ}\text{C}-260^{\circ}\text{C}$
		T3	$-40^{\circ}\text{C}-320^{\circ}\text{C}$
		T4	$-40^{\circ}\text{C}-420^{\circ}\text{C}$ (Only non-stop detachable type)
Protection grade		IP1	IP65
		IP2	IP67
		IP3	IP68